



alyans®
asansör

otomatik kapı sistemleri
automatic door systems



ANADOLU'dan
dünyaya açılan kapı

*From Anatolia to the world
Opened door*

Ürün Kataloğu / Product Catalogue

Hakkımızda / About us

Asansör sektöründe, üretim ve pazarlama alanında faaliyet gösteren ALYANS ASANSÖR, Ali AKYÜZ tarafından 2007 yılında kurulmuştur. Sahip olduğu tecrübe ve ürettiği kaliteli ürünler ile kısa sürede sektörde adından söz ettirmeyi başarmıştır.

Alyans Asansör tüm çalışanlarıyla birlikte, müşteri memnuniyetini sağlamayı ve evrensel kalite ve standartlarda ürün ve hizmet sunarak güvenilirlik, devamlılık, saygınlık ve dürüstlük sembolü olmayı kendine ilke edinmiştir.

Firmanın kurumsal değerleri ve kültürü, etik anlayışı ve iş ahlakı ilkeleri, sorumluluklarını yerine getirmesinde istekli olan işletme çalışanlarına yol göstererek daha büyük işler başarmada etkin rol oynamaktadır.

Alyans asansör, üstün kaliteli ve uygun maliyetli ürünler orataya koyarak, öncelikle Türkiye pazarında daha sonra Dünya pazarlarında bir marka olmayı kendine hedef olarak seçmiştir.

ALYANS ASANSÖR was established in 2007 by Ali AKYÜZ, which operates in the elevator industry as production and marketing. In a short time, has managed to make a name for itself in the sector, with experience and quality manufacturing.

ALYANS ASANSÖR has adopted the principle ensuring customer satisfaction, to be a symbol of reliability, continuity, respectability and honesty by offering products and services of universal quality and standards, with all employees.

The corporate values and culture, ethical understanding and business ethics of the company play an active role in achieving greater business by guiding the employees who are willing to accomplish their responsibilities.

ALYANS ASANSÖR decided as the target to become a brand first in the Turkish market and then in the world markets by producing high quality and cost-effective products.



ANADOLU'dan
dünyaya açılan kapı

*From Anatolia to the world
Opened door*





15 yıl önce başladı yolculuğumuz...

Heyecan dolu kalbimiz, girişimci ruhumuz, hayata ve insana olan sevgimizle...

İstedik ki yolculuğumuz mutluluk versin beraber yürüdüğümüz herkese...

Tek bir vidanın aslında bir bütünü temsil ettiği sorumluluğu ile baktık hep işimize...

Zorluklardan öğrendik,

Tecrübelerimizle büyüdük,

Müşterilerimizin güveni ile güçlendik,

Çalışanlarımızın gayretleri ve alın teri ile hep umutla baktık geleceğe...

Kazandırırken kazanmaktan mutlu olduk...

Ve bugün geldiğimiz noktada 40'ı aşan ürün çeşidimizle gerçek güvenin adı olduk...

Sizler için, ülkemiz için...

BİRLİKTE DAHA BÜYÜK BAŞARILARA ULAŞMAK ÜMİDİYLE...

Our journey started 15 years ago...

With Our heart full of excitement, our entrepreneurial spirit, our love of life and humanity...

We want to share the happiness of our journey together...

We have always looked to our business with the responsibility that a actually represents a whole...

We learned from the difficulties,

We grew up with our experiences,

We have strengthened with the trust of our customers,

With the efforts and dedication of our employees, we always look forward to the future with hope ...

We were happy to win, while earning ...

And today, at the point where we come, with more than 400 packaging types,

we have been the name of true confidence...

For you, for our country...

WITH THE HOPE OF ACHIEVING SUCCESS TOGETHER...

ANADOLU'dan dünyaya açılan kapı
From Anatolia to the world Opened door



2 PANEL

KAT - KABİN KAPISI
LANDING - CAR DOOR



EN 81-58 / EN 81-20/50 / EN 81-72



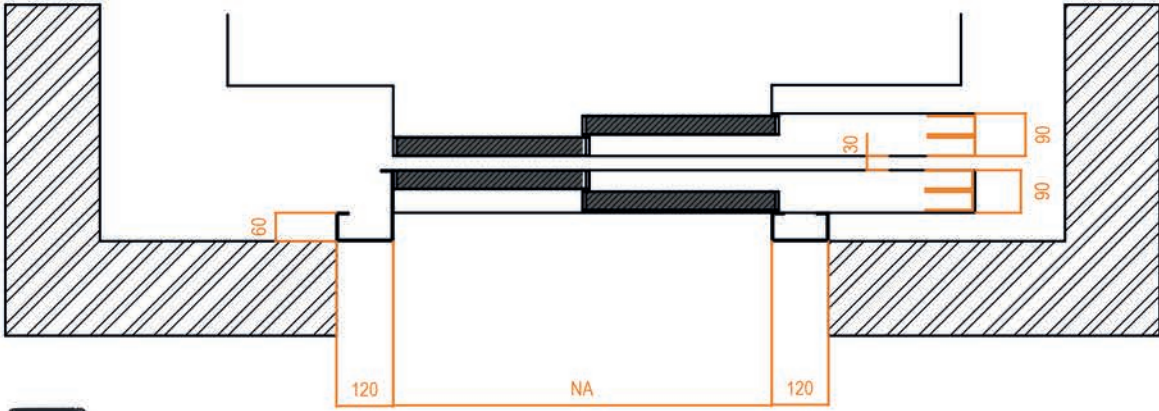

ÖZELLİKLER

- ▶ Kilit pozisyon ayarı
- ▶ Yay sertlik ayarı
- ▶ Panellerde 3 eksende ayar
- ▶ CE'li kilit sistemi
- ▶ Modern tasarımlar için çerçeveli CAM panel seçenekleri
- ▶ İnsan sağlığı ve güvenliği öne çıkan ürün tasarımı
- ▶ İsteğe bağlı olarak bütün renk ve desenlerde üretilebilirlik

FEATURES

- ▶ Setting the lock position
- ▶ Spring stiffness setting
- ▶ Adjustment of panels on 3 axes
- ▶ CE lock system
- ▶ Framed GLASS panel options for modern designs
- ▶ Product design with human health and safety features
- ▶ All colors and patterns can be produced on request

TEKNİK ÖZELLİKLER / TECHNICAL FEATURES

KAPI TİPİ	KAPI GENİŞLİĞİ MIN.	KAPI GENİŞLİĞİ MAX.	NET GİRİŞ YÜKSEKLİĞİ MIN	NET GİRİŞ YÜKSEKLİĞİ MAX	SIZDIRMAZLIK SINIFI			RENKLER DESENLER
DOOR TYPE	DOOR WIDTH MIN	DOOR WIDTH MAX	CLEAR HEIGHT MIN	CLEAR HEIGHT MAX	RESİSTANT CLASS			COLORS DESIGNS
					E	EI	EW	
ALYO-2	600	1300	2000	2300	60	30	60	RAL / PASLANMAZ RAL / STAINLESS

ANADOLU'dan dünyaya açılan kapı
From Anatolia to the world Opened door



2 PANEL MERKEZİ KAT - KABİN KAPISI CENTRAL LANDING - CAR DOOR



EN 81-58 / EN 81-20/50 / EN 81-72   

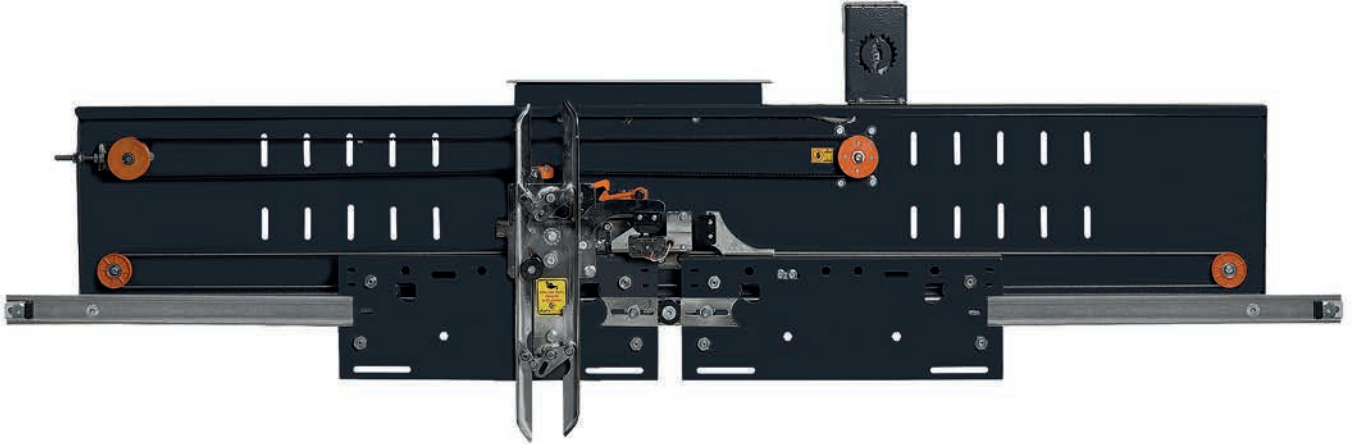
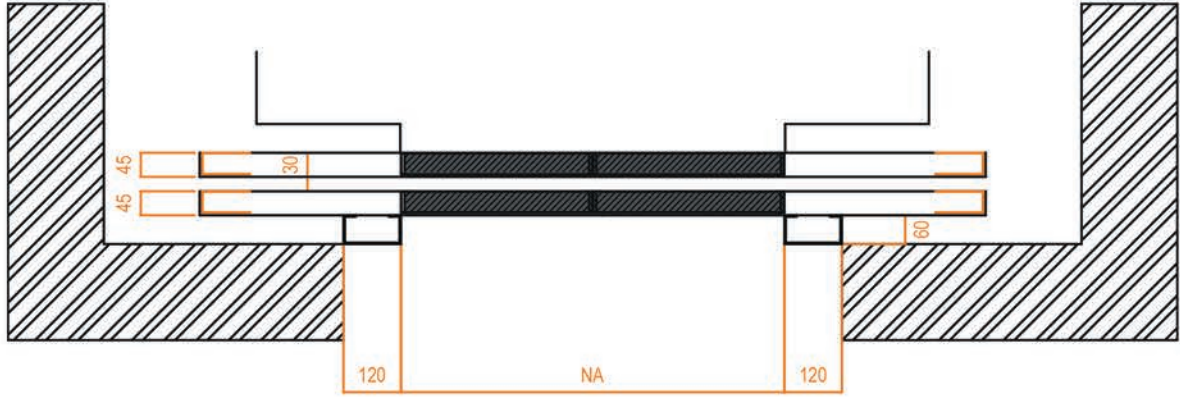
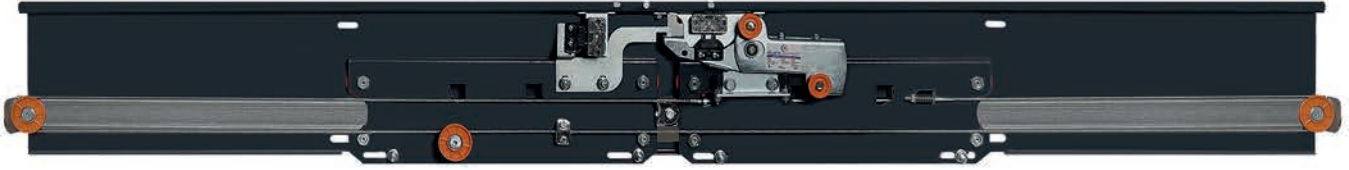

ÖZELLİKLER

- ▶ Kilit pozisyon ayarı
- ▶ Yay sertlik ayarı
- ▶ Panellerde 3 eksende ayar
- ▶ CE'li kilit sistemi
- ▶ Modern tasarımlar için çerçeveli CAM panel seçenekleri
- ▶ İnsan sağlığı ve güvenliği öne çıkan ürün tasarımı
- ▶ İsteğe bağlı olarak bütün renk ve desenlerde üretilebilirlik

FEATURES

- ▶ Setting the lock position
- ▶ Spring stiffness setting
- ▶ Adjustment of panels on 3 axes
- ▶ CE lock system
- ▶ Framed GLASS panel options for modern designs
- ▶ Product design with human health and safety features
- ▶ All colors and patterns can be produced on request

TEKNİK ÖZELLİKLER / TECHNICAL FEATURES

KAPI TİPİ	KAPI GENİŞLİĞİ MIN.	KAPI GENİŞLİĞİ MAX.	NET GİRİŞ YÜKSEKLİĞİ MIN	NET GİRİŞ YÜKSEKLİĞİ MAX	SIZDIRMAZLIK SINIFI	RENKLER DESENLER
DOOR TYPE	DOOR WIDTH MIN	DOOR WIDTH MAX	CLEAR HEIGHT MIN	CLEAR HEIGHT MAX	RESİSTANT CLASS	COLORS DESIGNS
ALYO-2M	600	1300	2000	2300	E EI EW	RAL / PASLANMAZ RAL / STAINLESS

ANADOLU'dan dünyaya açılan kapı
From Anatolia to the world Opened door



3 PANEL

KAT - KABİN KAPISI

LANDING - CAR DOOR

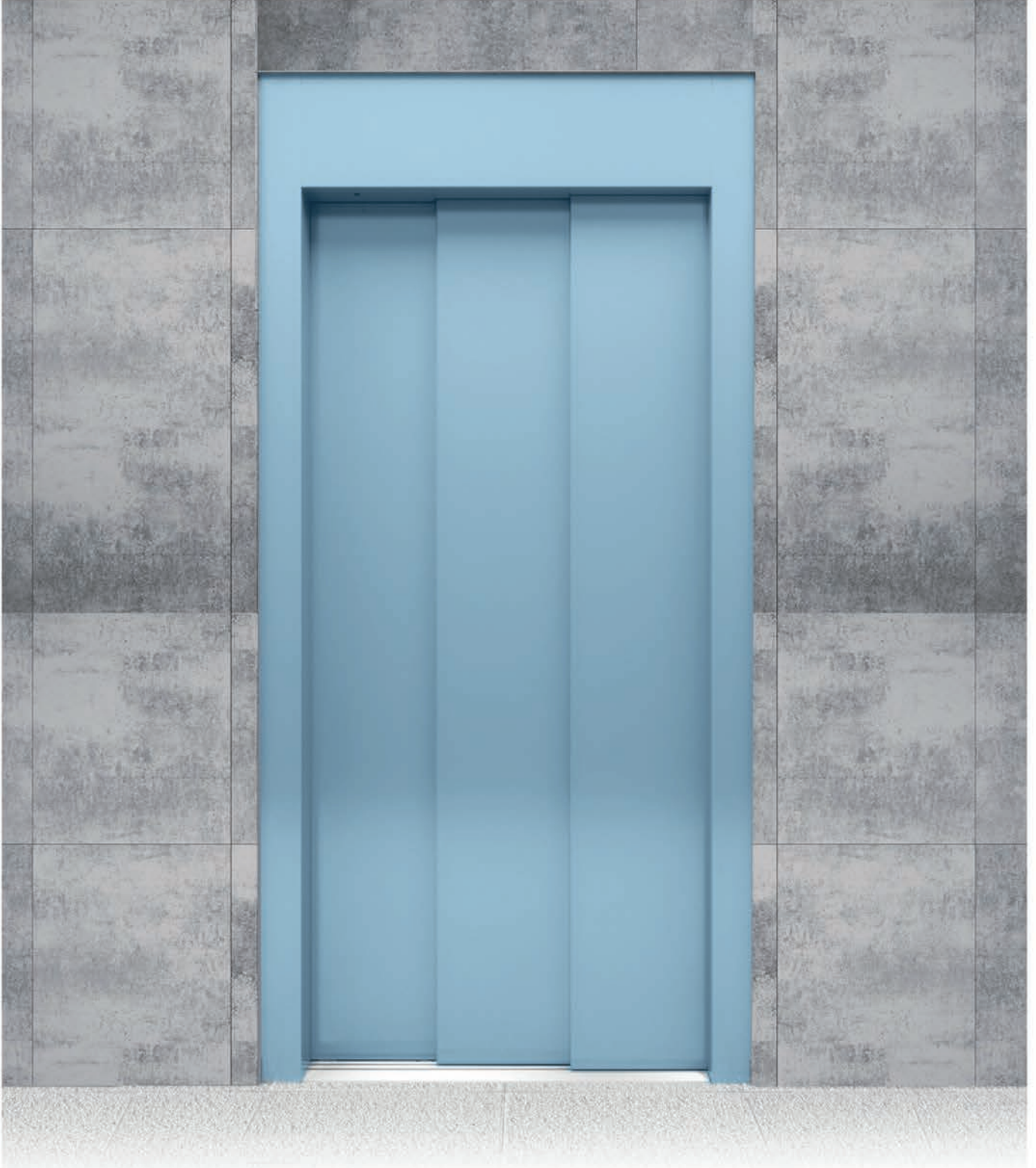

EN 81-58 / EN 81-20/50 / EN 81-72



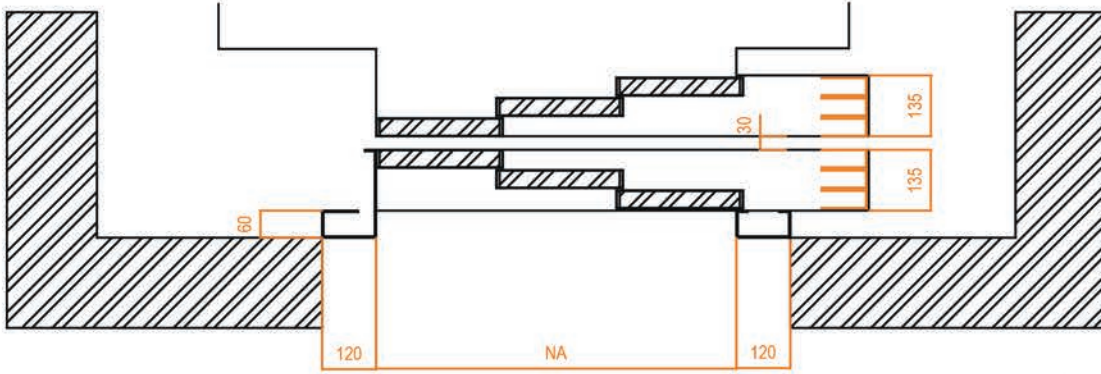

ÖZELLİKLER

- ▶ Kilit pozisyon ayarı
- ▶ Yay sertlik ayarı
- ▶ Panellerde 3 eksende ayar
- ▶ CE'li kilit sistemi
- ▶ Modern tasarımlar için çerçeveli CAM panel seçenekleri
- ▶ İnsan sağlığı ve güvenliği öne çıkan ürün tasarımı
- ▶ İsteğe bağlı olarak bütün renk ve desenlerde üretilebilirlik

FEATURES

- ▶ Setting the lock position
- ▶ Spring stiffness setting
- ▶ Adjustment of panels on 3 axes
- ▶ CE lock system
- ▶ Framed GLASS panel options for modern designs
- ▶ Product design with human health and safety features
- ▶ All colors and patterns can be produced on request

TEKNİK ÖZELLİKLER / TECHNICAL FEATURES

KAPI TİPİ	KAPI GENİŞLİĞİ MİN.	KAPI GENİŞLİĞİ MAX.	NET GİRİŞ YÜKSEKLİĞİ MİN	NET GİRİŞ YÜKSEKLİĞİ MAX	SIZDIRMAZLIK SINIFI	RENKLER DESENLER
DOOR TYPE	DOOR WIDTH MIN	DOOR WIDTH MAX	CLEAR HEIGHT MIN	CLEAR HEIGHT MAX	RESİSTANT CLASS E EI EW	COLORS DESIGNS
ALYO-3	700	1300	2000	2300	120 - -	RAL / PASLANMAZ RAL / STAINLESS

ANADOLU'dan dünyaya açılan kapı
From Anatolia to the world Opened door



4 PANEL

MERKEZİ KAT - KABİN KAPISI
CENTRAL LANDING - CAR DOOR



EN 81-58 / EN 81-20/50 / EN 81-72 / TSE / CE / EAC

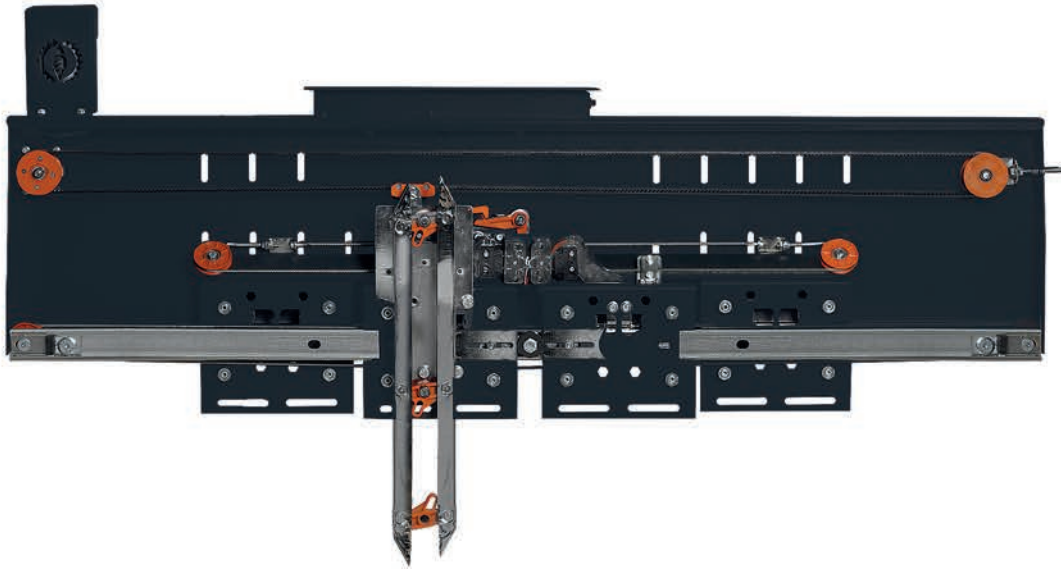
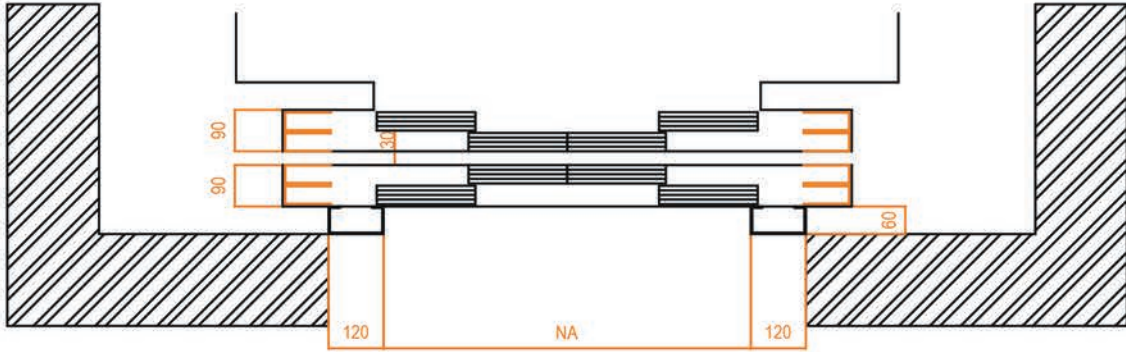
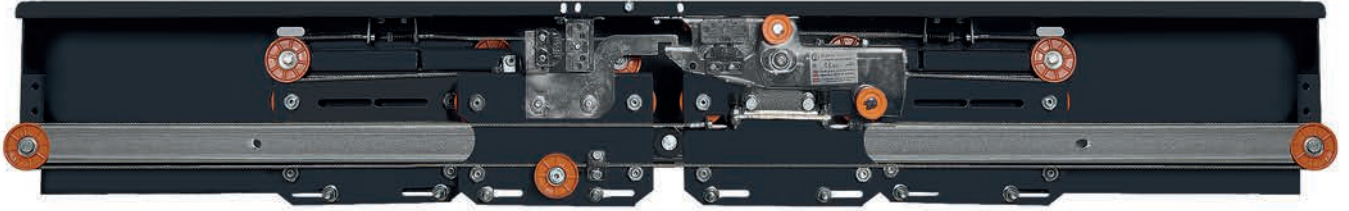

ÖZELLİKLER

- ▶ Kilit pozisyon ayarı
- ▶ Yay sertlik ayarı
- ▶ Panellerde 3 eksende ayar
- ▶ CE'li kilit sistemi
- ▶ Modern tasarımlar için çerçeveli CAM panel seçenekleri
- ▶ İnsan sağlığı ve güvenliği öne çıkan ürün tasarımı
- ▶ İsteğe bağlı olarak bütün renk ve desenlerde üretilebilirlik

FEATURES

- ▶ Setting the lock position
- ▶ Spring stiffness setting
- ▶ Adjustment of panels on 3 axes
- ▶ CE lock system
- ▶ Framed GLASS panel options for modern designs
- ▶ Product design with human health and safety features
- ▶ All colors and patterns can be produced on request

TEKNİK ÖZELLİKLER / TECHNICAL FEATURES

KAPI TİPİ	KAPI GENİŞLİĞİ MİN.	KAPI GENİŞLİĞİ MAX.	NET GİRİŞ YÜKSEKLİĞİ MİN	NET GİRİŞ YÜKSEKLİĞİ MAX	SIZDIRMAZLIK SINIFI	RENKLER DESENLER	
DOOR TYPE	DOOR WIDTH MIN	DOOR WIDTH MAX	CLEAR HEIGHT MIN	CLEAR HEIGHT MAX	RESİSTANT CLASS	COLORS DESIGNS	
					E	EI	EW
ALYO-4M	800	1300	2000	2300	120	-	-
							RAL / PASLANMAZ RAL / STAINLESS

ANADOLU'dan dünyaya açılan kapı
From Anatolia to the world Opened door



6 PANEL

MERKEZİ KAT - KABİN KAPISI
CENTRAL LANDING - CAR DOOR



EN 81-58 / EN 81-20/50 / EN 81-72   

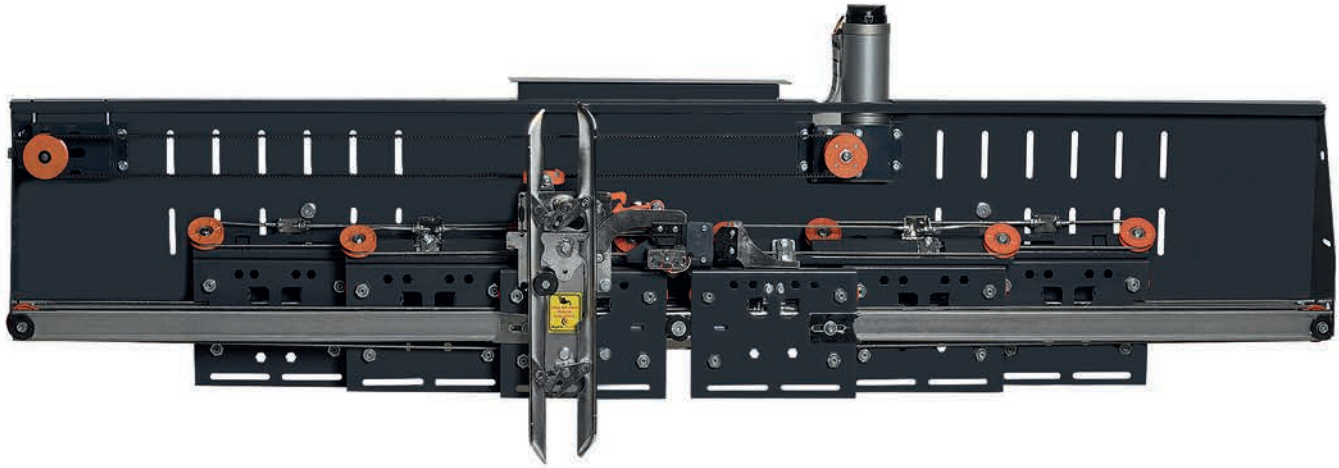
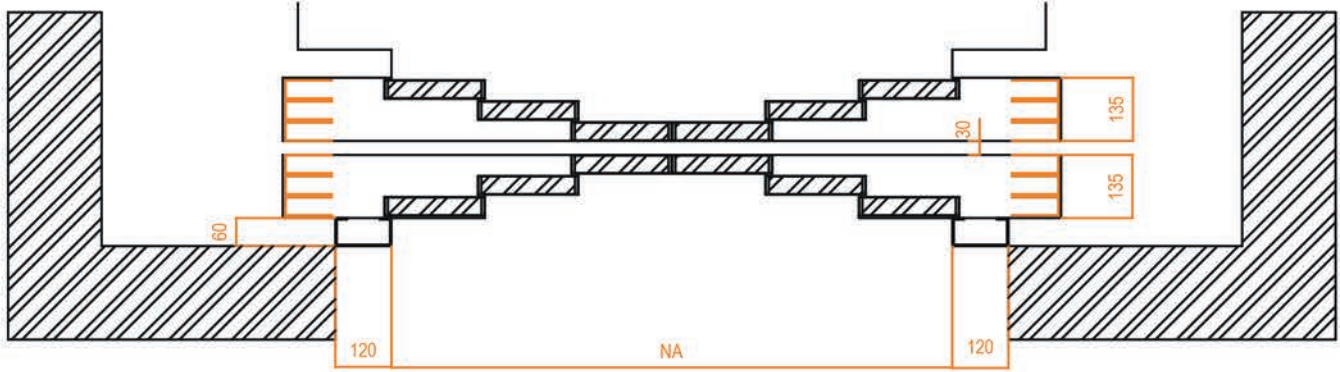
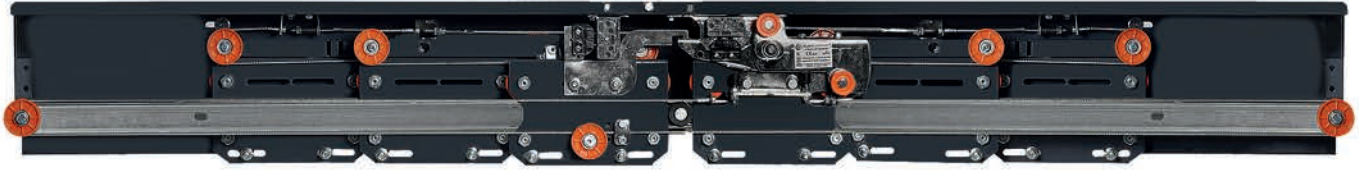

ÖZELLİKLER

- ▶ Kilit pozisyon ayarı
- ▶ Yay sertlik ayarı
- ▶ Panellerde 3 eksende ayar
- ▶ CE'li kilit sistemi
- ▶ Modern tasarımlar için çerçeveli CAM panel seçenekleri
- ▶ İnsan sağlığı ve güvenliği öne çıkan ürün tasarımı
- ▶ İsteğe bağlı olarak bütün renk ve desenlerde üretilebilirlik

FEATURES

- ▶ Setting the lock position
- ▶ Spring stiffness setting
- ▶ Adjustment of panels on 3 axes
- ▶ CE lock system
- ▶ Framed GLASS panel options for modern designs
- ▶ Product design with human health and safety features
- ▶ All colors and patterns can be produced on request

TEKNİK ÖZELLİKLER / TECHNICAL FEATURES

KAPI TİPİ	KAPI GENİŞLİĞİ MİN.	KAPI GENİŞLİĞİ MAX.	NET GİRİŞ YÜKSEKLİĞİ MİN	NET GİRİŞ YÜKSEKLİĞİ MAX	SIZDIRMAZLIK SINIFI	RENKLER DESENLER
DOOR TYPE	DOOR WIDTH MIN	DOOR WIDTH MAX	CLEAR HEIGHT MIN	CLEAR HEIGHT MAX	RESİSTANT CLASS	COLORS DESIGNS
ALYO-6M	1200	2600	2000	2300	E EI EW	RAL / PASLANMAZ RAL / STAINLESS

ANADOLU'dan dünyaya açılan kapı
From Anatolia to the world Opened door

KRAMER KABİN KAPISI **FOLDING CABIN DOOR**

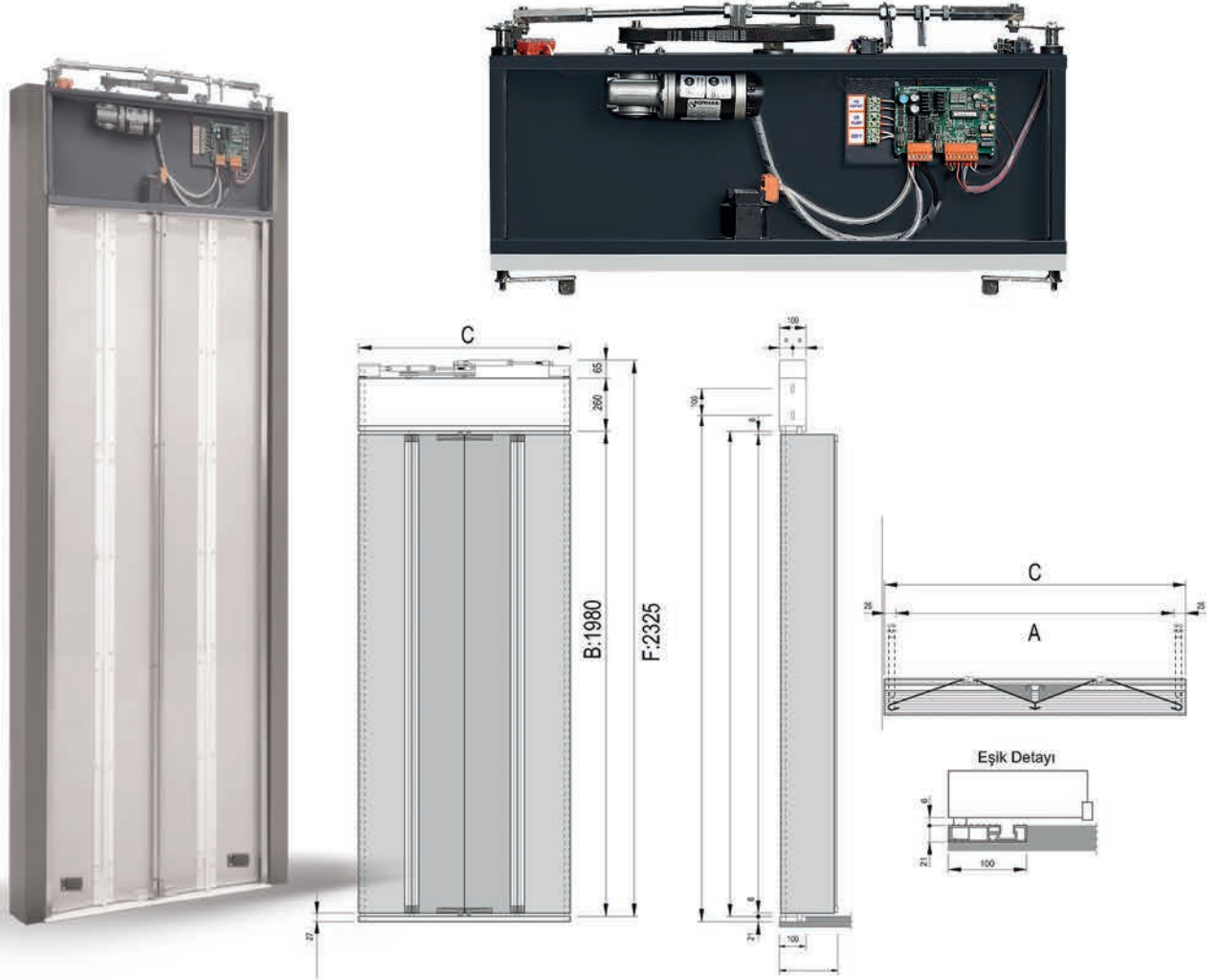

TEKNİK ÖZELLİKLER / TECHNICAL FEATURES

A	500	550	600	650	700	750	800	850	900	950	1000	1050	1100	1150
C	550	600	650	700	750	800	850	900	950	1000	1050	1100	1150	1200
TIME (S)	2,8			3,4				3,7			3,9			
WEIGHT (KG)	35	39	41	43	46	48	50	52	54	56	58	60	62	64

ÖZELLİKLER

- ▶ 24 V DC redüktörlü motor
- ▶ Akü ve fotosel çıkışı
- ▶ 220 V AC ve lyrepump voltajı ile çalışabilme
- ▶ Tek sinyal(kapama sinyali)ile çalışabilme
- ▶ Limit anahtarlı çalışma
- ▶ Kapı sıkışma algoritması ile güvenli çalışma
- ▶ Ters motor bağlantı uyarısı
- ▶ Encoderli ve encodersiz kullanım imkanı

FEATURES

- ▶ 24 V DC reducer motor
- ▶ Battery and photocell output
- ▶ Working with 220 V AC and lyrepump voltage
- ▶ Working with single signal(close signal)
- ▶ Working with limit switch
- ▶ Safe operation with the door jam algorithm
- ▶ Reverse motor connection warning
- ▶ Opportunity to use with and without encoder

2 PANEL KABİN KAPISI CAR DOOR



ÖZELLİKLER

- ▶ Yeni mekanik dizayn ile yüksek konfor
- ▶ Redüktörlü ve BLDC motor sistemine uyumlu çalışabilme
- ▶ Sıkışma anında geri açılır
- ▶ Ağır hizmet kapılarına uyum sağlama
- ▶ Düşük enerji tüketimi
- ▶ Şebeke gerilim değişimlerinde yüksek tolerans çalışma

FEATURES

- ▶ High comfort with a new mechanical design
- ▶ Working compatible with reducer and bldc motor system
- ▶ Reopening special feature in case of jam
- ▶ Adaptation to constantly working doors
- ▶ Low energy consumption
- ▶ High tolerance operation in the network voltage fluctuations

2 PANEL YARI OTOMATİK KABİN KAPISI SEMI AUTOMATIC CAR DOOR



ÖZELLİKLER

- ▶ 220 V AC 50 hz ve İyrepump voltajı ile çalışabilme
- ▶ Mikrodenetleyici ile kumanda edilir.
- ▶ Sıkışma anında geri açılır
- ▶ Akü desteği

FEATURES

- ▶ Operated by 220 V AC 50 hz and İyrepump voltage
- ▶ Controlled by microcontrolled
- ▶ Reopening special feature in case of jam
- ▶ Battery support

ANADOLU'dan dünyaya açılan kapı
From Anatolia to the world Opened door



DEKORATİF PASLANMAZ MODELLER DECORATIVE STAINLESS MODELS

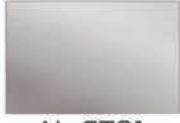

AL-ST01



AL-ST02



AL-ST03

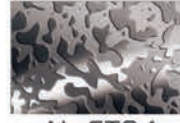

AL-ST04



AL-ST05



AL-ST06



AL-ST07



AL-ST08



AL-ST09

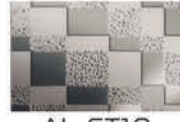

AL-ST10



AL-ST11



AL-ST12



AL-ST13

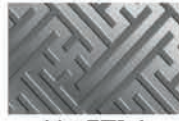

AL-ST14



AL-ST15



AL-ST16

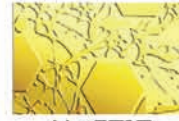

AL-ST17

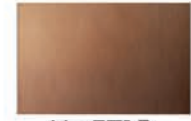

AL-ST18



AL-ST19



AL-ST20



AL-ST21



AL-ST22



AL-ST23



AL-ST24



AL-ST25



AL-ST26



AL-ST27



AL-ST28



AL-ST29



AL-ST30

RAL RENKLER RAL COLORS



RAL 5002



RAL 7032



RAL 7040



RAL 8011



RAL 2008



RAL 9005



RAL 5015



RAL 7016



RAL 3020



RAL 6029



RAL 2004



RAL 3002



RAL 7035

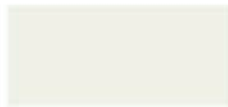

RAL 9016



RAL 7024

KONTROL KARTI CONTROL CARD

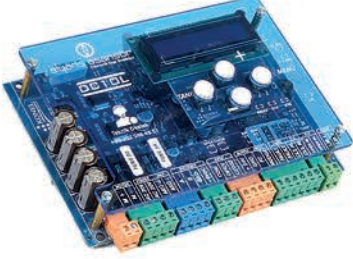

ÖZELLİKLER

- ▶ 20 V AC veya 24 V DC çalışabilme
- ▶ Redüktörlü DC motor kontrolünde profesyonel sürücü kartı
- ▶ Sınır anahtara ihtiyaç kalmadan limitleri tanır
- ▶ Sıkışma algoritması ile engel tanıma
- ▶ Akü desteği
- ▶ Yüksek çözünürlükte mesafe ölçümü
- ▶ Türkçe ve İngilizce dil desteği

FEATURES

- ▶ 20 V AC or 24 V DC operation
- ▶ Professional driver board in reduced DC motor control
- ▶ Identification limits without the need for a limit key switch
- ▶ Obstacle recognition with jam algorithm
- ▶ Battery support
- ▶ High resolution distance measurement
- ▶ Turkish and english language supports

MOTOR



ÖZELLİKLER

- ▶ 24 V DC redüktörlü motor
- ▶ 100 watt
- ▶ 15.1 dişli oranı
- ▶ Yüksek hızda max konfor

FEATURES

- ▶ 24 V DC reducer motor
- ▶ 100 watt
- ▶ 15.1 gear ratio
- ▶ Max comfort at high speed

KAŞIK SKATE

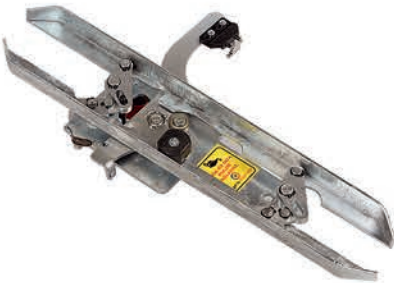

ÖZELLİKLER

- ▶ Düşük enerji tüketimi
- ▶ Yükten bağımsız çalışabilme özelliği
- ▶ Farklı motor ve kontrol kart ile çalışabilme
- ▶ Metal yapısı ile yüksek dayanıklılık

KİLİT LOCK



FEATURES

- ▶ Low energy consumption
- ▶ Load-independent operation feature
- ▶ Working with different motor and control board
- ▶ High durability with metal structure

YEDEK PARÇALAR SPARE PARTS

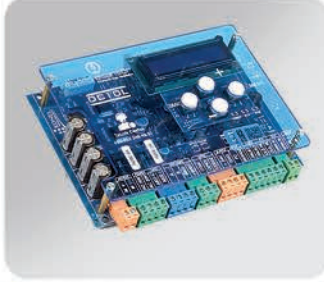

ALYO-01
Otomatik Kapı Kartı
Automatic Door Card



ALYO-02
Otomatik Kapı Motoru
Automatic Door Motor

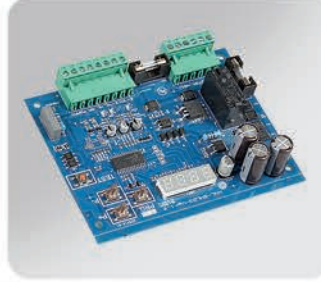

ALYO-03
Yarı Otomatik Kapı Kartı
Semi-Automatic Door Card



ALYO-04
Yarı Otomatik Kapı Motoru
Semi-Automatic Door Motor



ALYO-05
100 W Trafo
100 W Transformer



ALYO-06
60 W Trafo
60 W Transformer



ALYO-07
Kaşık / 81-20
Skate / 81-20



ALYO-08
Kaşık / A3
Skate / A3



ALYO-09
Kayış
Strap



ALYO-10
Kat Kapısı Kilit Takımı
Landing Door Lock Set



ALYO-11
Kasa Kancalı Halat
Case Hook Rope



ALYO-12
Mekanizma Halatı
Mechanism Rope



ALYO-13
8 mm Kaşık Aparatı
8 mm Skate Device



ALYO-14
Kabin Kapısı Askı Civatası
Cabin Door Hanger Bolt



ALYO-15
Kat Kapısı Askı Civatası
Landing Door Hanger Bolt



ALYO-16
Kaşık Kilitleme
Skate locking



ALYO-17
Sac Fişkontak
Sheet Metal Plug Contact



ALYO-18
Z Destek Sac
Support Sheet



ALYO-19
Etek Sacı
Sheet Metal (Apron)



ALYO-20
Kasa Yayı
Case Spring



ALYO-21
Fiş Kontak
Plug Contact



ALYO-22
Fiş Kontak
Plug Contact



ALYO-23
Fiş Kontak
Plug Contact



ALYO-24
Fiş Kontak
Plug Contact



ALYO-25
Büyük Eksantrik Teker
Big Eccentric Wheel



ALYO-26
Büyük Düz Teker
Big Flat Wheel



ALYO-27
Küçük Eksantrik Teker
Small Eccentric Wheel



ALYO-28
Halat Tekerli
Rope Wheel



ALYO-29
Motor Dişlisi
Engine Gear



ALYO-30
Kayış Gergil Dişlisi
Strap Tension Gear



ALYO-31
Kelebek Takımı
Butterfly Team



ALYO-32
Kasa Kilidli
Case Lock



ALYO-33
Alüminyum Kızak
Aluminum Slide



ALYO-34
Merkezi Alüminyum Kızak
Central Aluminum Slide



ALYO-35
Konsol
Console



ALYO-36
Vida Kutusu
Screw Box



ALYO-37
Kontak
Switch

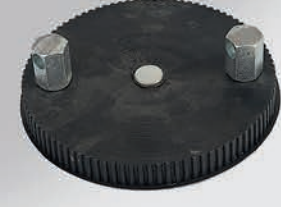

ALYO-38
Kramer Kasnak
Folding Pulley



ALYO-39
Kramer Ayak
Folding Foot



ALYO-40
Kramer Kayış
Folding Strap





otomatik kapı sistemleri
automatic door systems

**Tecrübeli kadromuzla
dünyanın her yerindeyiz**

**we are all over the world
with our experienced staff**





Fevzi Çakmak Mahallesi. Ayyıldız Caddesi
4MK San Sit No: 99/D Karatay / KONYA TÜRKİYE
Tel: +90 332 346 45 51 - Fax: +90 332 346 45 52
info@alyanslift.com www.alyanslift.com

